

Rosemount 248 Temperature Transmitter



- Basic temperature transmitter offers a reliable solution for temperature monitoring points.
- Standard transmitter design provides flexible and reliable performance in process environments.
- Experience lower over-all installation costs when compared to wiring sensor directly, reducing the need for expensive extension wires and multiplexers.
- Explore the benefits of a Complete Point Solution from Rosemount Temperature.

Rosemount 248 Temperature Transmitter

Basic temperature transmitter offers a cost effective solution for temperature monitoring points



- DIN B style head mount transmitter
- Variety of DIN B enclosure options
- Rail mount
- HART®/4-20 mA protocol
- Single sensor capability with universal sensor inputs (RTD, T/C, mV, ohms)

Standard transmitter design provides flexible and reliable performance in process environments

- Offers improved measurement accuracy and reliability over direct-wiring a sensor to the digital control system for a lower overall installation cost
- One-year stability rating reduces maintenance costs
- Open/short sensor diagnostics assist with detecting issues in the sensor loop
- Compensation for ambient temperatures enhances transmitter performance

Explore the benefits of a complete point solution from Rosemount Temperature Measurement

- An “Assemble To Sensor” option enables Emerson to provide a complete point temperature solution, delivering an installation-ready transmitter and sensor assembly
- Emerson offers a selection of RTDs, thermocouples, and thermowells that bring superior durability and Rosemount reliability to temperature sensing, complementing the Rosemount Transmitter portfolio

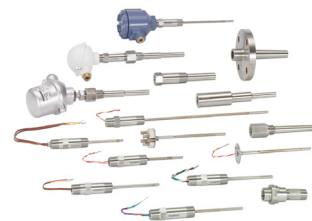

Experience global consistency and local support from numerous worldwide Rosemount Temperature manufacturing sites



- World-class manufacturing provides globally consistent product from every factory and the capacity to fulfill the needs of any project, large or small
- Experienced Instrumentation Consultants help select the right product for any temperature application and advise on best installation practices
- An extensive global network of Emerson service and support personnel can be on-site when and where they are needed

Contents

Rosemount 248 Temperature Transmitter	page 4	Dimensional Drawings	page 19
Transmitter Specifications	page 9	Rosemount 248 Configuration Interface Specifications	page 20
Product Certifications	page 14		

Rosemount 248 Temperature Transmitter



Rosemount 248 Head Mount Temperature Transmitter

The Rosemount 248 Temperature Transmitter has a standard transmitter design that provides flexible and reliable performance in process environments.

Transmitter features include:

- HART/4-20 mA Communication Protocol
- DIN B style head mount and rail mount transmitter types
- Variety of DIN B enclosure options
- Sanitary Connection Heads available (Option Code F and S)
- 3-Point Calibration Certificate (Option Code Q4)
- Assemble to Sensor options (Option Code XA)

Specification and selection of product materials, options, or components must be made by the purchaser of the equipment. See [page 10](#) for more information on Material Selection.

Table 1. Rosemount 248 Head Mount Temperature Transmitter

★ The Standard offering represents the most common options. The starred options (★) should be selected for best delivery. The Expanded offering is subject to additional delivery lead time.

Model	Product description		
248	Temperature Transmitter		
Transmitter type			
H	DIN B Head Mount		★
Transmitter output			
A	4–20 mA with digital signal based on HART Protocol		★
Product certifications			Enclosure option codes permitted
E5	FM Explosion-Proof	A, U, G, H	★
I5	FM Intrinsic Safety and Class I, Division 2	A, B, U, N, G, S, H	★
K5	FM Intrinsic Safety, Explosion-Proof, and Class I, Division 2	A, U, G, H	★
I6	CSA Intrinsic Safety and Class I, Division 2	A, B, U, N, G, H	★
K6	CSA Intrinsic Safety, Explosion-Proof, and Class I, Division 2	A, U, G, H	★
E1	ATEX Flameproof	A, U, G, H	★
I1	ATEX Intrinsic Safety	A, B, U, N, C, G, S, H	★
ND	ATEX Dust	A, U, G, H	★
N1	ATEX Type n	A, U, G, H	★
NC ⁽¹⁾	ATEX Type n Component	N	★

Table 1. Rosemount 248 Head Mount Temperature Transmitter

★ The Standard offering represents the most common options. The starred options (★) should be selected for best delivery.

The Expanded offering is subject to additional delivery lead time.

E7	IECEX Flameproof and Dust	A, U, G, H	★
I7	IECEX Intrinsic Safety	All options	★
N7	IECEX Type n	A, U, G, H	★
NG	IECEX Type n Component	N	★
KM	Technical Regulations Customs Union (EAC) Flameproof, Intrinsic Safety	A, G, H, U	★
IM	Technical Regulations Customs Union (EAC) Intrinsic Safety	All options	★
EM	Technical Regulations Customs Union (EAC) Flameproof	A, G, H, U	★
E3	China Flameproof	A, G, H, N	★
I3	China Intrinsic Safety	A, G, H, N	★
NA	No Approval	All options	★
Enclosure		Material	IP rating
A	Connection Head	Aluminum	IP66/68
B	BUZ Head	Aluminum	IP65
C	BUZ Head	Polypropylene	IP65
G	Connection Head	SST	IP66/IP68
H	Universal Head (Junction Box)	SST	IP66/IP68
U	Universal Head (Junction Box)	Aluminum	IP66/IP68
N	No Enclosure	N/A	N/A
F	Sanitary Connection Head, DIN A	Polished SST	IP66/IP68
S	Sanitary Connection Head, DIN B	Polished SST	IP66/IP68
Conduit entry size⁽²⁾			
1 ⁽³⁾	M20 x 1.5 (CM20)		★
2	1/2-inch NPT		★
0	No Enclosure		★
Assemble to options			
XA	Sensor Specified Separately and Assembled to Transmitter		★
NS	No Sensor		★

Options (include with selected model number)

Alarm level configuration		
A1	NAMUR alarm and saturation levels, high alarm	★
CN	NAMUR alarm and saturation levels, low alarm	★
5-point calibration		
C4	5-Point Calibration (requires the Q4 option code to generate a Calibration Certificate)	★

Table 1. Rosemount 248 Head Mount Temperature Transmitter

★ The Standard offering represents the most common options. The starred options (★) should be selected for best delivery.

The Expanded offering is subject to additional delivery lead time.

Calibration certificate		
Q4	Calibration Certificate (3-point calibration)	★
External ground		
G1	External Ground Lug Assembly	★
Line filter		
F6	60 Hz Line Voltage Filter	★
Conduit electrical connector		
GE ⁽²⁾⁽⁴⁾	M12, 4 pin, Male Connector (eurofast [®])	★
GM ⁽²⁾⁽⁴⁾	A-size Mini, 4 pin, Male Connector (minifast [®])	★
External label		
EL	External Label for ATEX Intrinsic Safety	★
Cover chain option		
G3	Cover Chain	★
Software configuration		
C1	Custom Configuration of Date, Descriptor and Message (requires CDS with order)	★
Extended product warranty		
WR3	3-year warranty	★
WR5	5-year warranty	★
Typical model number: 248H A I1 A 1 DR N080 T08 EL U250 CN		

(1) The 248H with ATEX Type n Component Approval is not approved as a stand alone unit, additional system certification is required. Transmitter must be installed so it is protected to at least the requirements of IP54.

(2) All process connection threads are $\frac{1}{2}$ in. NPT, except for Enclosure Codes H and U with Conduit Entry Code 1 and Sensor Type Code NS.

(3) For enclosures H and U with the XA option specified, a $\frac{1}{2}$ in. NPT to M20 x 1.5 thread adapter is used.

(4) Available with Intrinsically Safe approvals only for FM Intrinsically Safe or Non-Incendive approval (Option Code I5). To maintain NEMA 4X rating, it must be installed according to Rosemount Drawing 03151-1009.



Rosemount 248R Rail Mount Transmitter

The Rosemount 248 Temperature Transmitter has a standard transmitter design that provides flexible and reliable performance in process environments.

Transmitter features include:

- HART/4-20 mA communication protocol
- Rail mount transmitter type
- 3-Point Calibration Certificate (Option Code Q4)
- Custom Configuration of Software Parameters (Option Code C1)

Table 2. Rosemount 248R Rail Mount Transmitter

★ The Standard offering represents the most common options. The starred options (★) should be selected for best delivery. The Expanded offering is subject to additional delivery lead time.

Model	Product description	
248R	Rail Mount Temperature Transmitter	
Output protocol		
A	4-20 mA with digital signal based on HART protocol	★
Product certifications		
I5	FM Intrinsically Safe and Class I, Division 2	★
I6	CSA Intrinsically Safe and Class I, Division 2	★
I1	ATEX Intrinsic Safety	★
NC	ATEX Type n Component	★
I7 ⁽¹⁾	IECEx Intrinsic Safety	★
IM	GOST (Russia) Intrinsically Safe	★
NA	No Approvals	★

Options (include with selected model number)

Software configuration		
C1	Custom Configuration of enters date, descriptor and message (CDS required with order)	★
Alarm level configuration		
A1	NAMUR alarm and saturation levels, high alarm	★
CN	NAMUR alarm and saturation levels, low alarm	★
5-point calibration		
C4	5-Point Calibration (requires the Q4 option code to generate a Calibration Certificate)	★
Calibration certificate		
Q4	Calibration Certificate (3-point calibration)	★

Table 2. Rosemount 248R Rail Mount Transmitter

★ The Standard offering represents the most common options. The starred options (★) should be selected for best delivery.

The Expanded offering is subject to additional delivery lead time.

Line filter		
F6	60 Hz Line Voltage Filter	★
Mounting style		
GR	G-Rail Mounting	★
Extended product warranty		
WR3	3-year warranty	★
WR5	5-year warranty	★
Typical model number: 248R A I1 Q4		

(1) Consult factory for availability.

Transmitter Specifications

Functional specifications

Inputs

User-selectable; sensor terminals rates to 42.4 Vdc. See “Transmitter accuracy and ambient temperature effects” on page 12 for sensor options.

Output

2-wire 4–20 mA, linear with temperature or input; digital output signal superimposed on 4–20 mA signal, available for a Field Communicator or control system interface.

Isolation

Input/output isolation tested to 500 Vac rms (707 Vdc) at 50/60 Hz.

Power supply

An external power supply is required for HART devices. The transmitter operates on 12.0 to 42.4 Vdc transmitter terminal voltage with load resistance between 250 and 1100 ohms. A minimum of 17.75 Vdc power supply is required with a load of 250 ohms. Transmitter power terminals are rated to 42.4 Vdc.

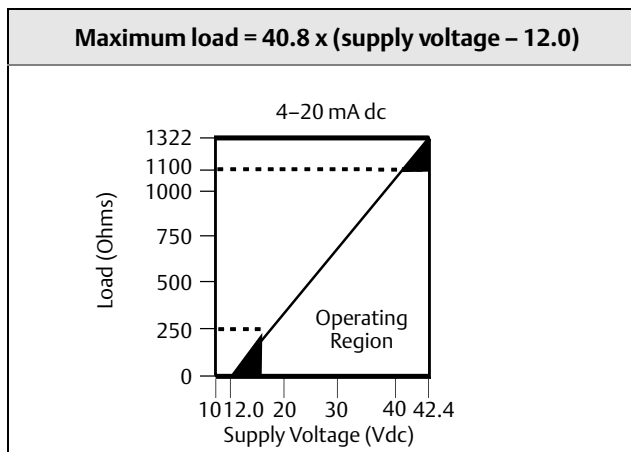

Humidity limits

0–99% relative humidity, non-condensing

NAMUR recommendations

The 248 meets the following NAMUR recommendations:

- NE 21 – Electromagnetic compatibility (EMC) for Process and Laboratory Apparatus
- NE 43 – Standard of the signal level breakdown information of digital transmitters
- NE 89 – Standard of temperature transmitters with digital signal processing

Transient protection

The optional Rosemount 470 Transient Protector prevents damage from transients induced by lightning, welding, heavy electrical equipment, or switch gears. Refer to the 470 Product Data Sheet (document number 00813-0100-4191) for more information.

Temperature limits

Operating Limit

- –40 to 85 °C (–40 to 185 °F)

Storage Limit

- –50 to 120 °C (–58 to 248 °F)

Turn-on time

Performance within specifications in less than 5.0 seconds after power is applied to transmitter, when damping value is set to zero seconds.

Update rate

Less than 0.5 seconds

Damping

32 seconds maximum. 5 seconds default

Custom alarm and saturation levels

Custom factory configuration of alarm and saturation levels is available with option code C1 for valid values. These values can also be configured in the field using a Field Communicator.

Recommended minimum measuring span

10 K

Software detected failure mode

The values at which the transmitter drives its output in failure mode depends on whether it is configured to standard, custom, or NAMUR-compliant (NAMUR recommendation NE 43) operation. The values for standard and NAMUR-compliant operation are as follows:

Figure 1. Operation Parameters

	Standard ⁽¹⁾	NAMUR NE43-compliant ⁽¹⁾
Linear Output	3.9 ≤ I ≤ 20.5	3.8 ≤ I ≤ 20.5
Fail High	21 ≤ I ≤ 23 (default)	21 ≤ I ≤ 23 (default)
Fail Low	I ≤ 3.75	I ≤ 3.6

(1) Measured in milliamperes.

Certain hardware failures, such as microprocessor failures, will always drive the output to greater than 23 mA.

Physical specifications

Material selection

Emerson provides a variety of Rosemount product with various product options and configurations including materials of construction that can be expected to perform well in a wide range of applications. The Rosemount product information presented is intended as a guide for the purchaser to make an appropriate selection for the application. It is the purchaser's sole responsibility to make a careful analysis of all process parameters (such as all chemical components, temperature, pressure, flow rate, abrasives, contaminants, etc.), when specifying product, materials, options and components for the particular application. Emerson Process Management is not in a position to evaluate or guarantee the compatibility of the process fluid or other process parameters with the product, options, configuration or materials of construction selected.

Conformance to specification [$\pm 3\sigma$ (Sigma)]

Technology leadership, advanced manufacturing techniques, and statistical process control ensure specification conformance to at least $\pm 3\sigma$.

Field Communicator connections

Communication Terminal: clips permanently fixed to the terminals

Materials of construction

Electronics housing

Reinforced GE polyphenylene oxide glass

Universal (option code U and H) and Rosemount connection (option code A and G) heads

- Housing: Low-copper aluminum (option codes U and A)
- Stainless Steel (option codes G and H)
- Paint: Polyurethane
- Cover O-Ring: Buna-N

BUZ head (option code B)

- Housing: Aluminum
- Paint: Aluminum lacquer
- O-Ring Seal: Rubber

Mounting

The 248R attaches directly to a wall or a DIN rail. The 248H installs in a connection head or universal head mounted directly on a sensor assembly or apart from a sensor assembly using a universal head. The 248H can also mount to a DIN rail using an optional mounting clip (see [Table 7](#)).

Weight

Code	Options	Weight
248H	Headmount Transmitter	42 g (1.5 oz)
248R	Railmount Transmitter	250 g (8.8 oz)
U	Universal Head	520 g (18.4 oz)
B	BUZ Head	240 g (8.5 oz)
C	Polypropylene Head	90 g (3.2 oz.)
A	Rosemount Connection Head	524 g (18.5 oz)
S	Polished Stainless Steel (SST) Head	537 g (18.9 oz)
G	Rosemount Connection Head (SST)	1700 g (60 oz)
H	Universal Head (SST)	1700 g (60 oz)

Enclosure ratings

The Universal (option code U) and Rosemount Connection (option code A) Heads are NEMA 4X, IP66, and IP68. The Universal Head with $1/2$ NPT threads is CSA Enclosure Type 4X. The BUZ head (option code B) is NEMA 4 and IP65.

Performance specifications

Electromagnetic compatibility (EMC)

NAMUR NE21 Standard

The Rosemount 248 meets the requirements for NAMUR NE21 Rating.

Susceptibility	Parameter	Influence
ESD	<ul style="list-style-type: none"> 6 kV contact discharge 8 kV air discharge 	None
Radiated	<ul style="list-style-type: none"> 80 – 1000 MHz at 10 V/m AM 	None
Burst	<ul style="list-style-type: none"> 1 kV for I.O. 	None
Surge	<ul style="list-style-type: none"> 0.5 kV line–line 1 kV line–ground (I.O. tool) 	None
Conducted	<ul style="list-style-type: none"> 150 kHz to 80 MHz at 10 V 	None

CE mark

The 248 meets the requirements listed in IEC 61326-1:2006 and IEC 61326-2-3:2006.

Power supply effect

Less than ±0.005% of span per volt

Vibration effect

Tested to the following with no effect on performance per IEC 60770-1, 1999:

Frequency	Vibration
10 to 60 Hz	0.21 mm displacement
60 to 2000 Hz	3 g peak acceleration

Stability

For RTD and thermocouple inputs the transmitter will have a stability of ±0.1% of reading or 0.1 °C (whichever is greater) for twelve months

Self calibration

The analog-to-digital measurement circuitry automatically self-calibrates for each temperature update by comparing the dynamic measurement to extremely stable and accurate internal reference elements.

Sensor connections

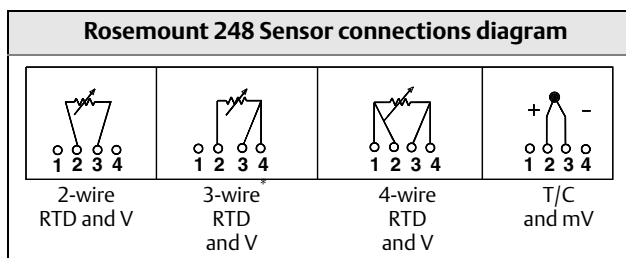

* Rosemount Inc. provides 4-wire sensors for all single element RTDs. You can use these RTDs in 3-wire configurations by leaving the unneeded leads disconnected and insulated with electrical tape.

Transmitter accuracy and ambient temperature effects

Note

The accuracy and ambient temperature effect is the greater of the fixed and percent of span values (see example).

Table 3. Rosemount 248 Transmitter Input Options, Accuracy, and Ambient Temperature Effects

Sensor	Transmitter input ranges ⁽¹⁾		Accuracy		Temperature effects per 1.0 °C (1.8 °F) change in ambient temperature ⁽²⁾⁽³⁾⁽¹²⁾	
	°C	°F	Fixed	% of span	Fixed	% of span
2-, 3-, 4-wire RTDs						
Pt 100 ⁽⁴⁾ ($\alpha=0.00385$)	-200 to 850	-328 to 1562	0.2 °C (0.36 °F)	±0.1	0.006 °C (0.011 °F)	±0.004
Pt 100 ⁽⁵⁾ ($\alpha=0.003916$)	-200 to 645	-328 to 1193	0.2 °C (0.36 °F)	±0.1	0.006 °C (0.011 °F)	±0.004
Pt 200 ⁽⁴⁾	-200 to 850	-328 to 1562	1.17 °C (2.11 °F)	±0.1	0.018 °C (0.032 °F)	±0.004
Pt 500 ⁽⁴⁾	-200 to 850	-328 to 1562	0.47 °C (0.85 °F)	±0.1	0.018 °C (0.032 °F)	±0.004
Pt 1000 ⁽⁴⁾	-200 to 300	-328 to 572	0.23 °C (0.41 °F)	±0.1	0.010 °C (0.018 °F)	±0.004
Ni 120 ⁽⁶⁾	-70 to 300	-94 to 572	0.16 °C (0.29 °F)	±0.1	0.004 °C (0.007 °F)	±0.004
Cu 10 ⁽⁷⁾	-50 to 250	-58 to 482	2 °C (3.60 °F)	±0.1	0.06 °C (0.108 °F)	±0.004
Cu 50 ($\alpha=0.00428$)	-185 to 200	-365 to 392	0.68 °C (1.22 °F)	±0.1	0.012 °C (0.022 °F)	±0.004
Cu 100 ($\alpha=0.00428$)	-185 to 200	-365 to 392	0.34 °C (0.61 °F)	±0.1	0.006 °C (0.011 °F)	±0.004
Cu 50 ($\alpha=0.00426$)	-50 to 200	-122 to 392	0.68 °C (1.22 °F)	±0.1	0.012 °C (0.022 °F)	±0.004
Cu 100 ($\alpha=0.00426$)	-50 to 200	-122 to 392	0.34 °C (0.61 °F)	±0.1	0.006 °C (0.011 °F)	±0.004
PT 50 ($\alpha=0.00391$)	-200 to 550	-392 to 1022	0.40 °C (0.72 °F)	±0.1	0.012 °C (0.022 °F)	±0.004
PT 100 ($\alpha=0.00391$)	-200 to 550	-392 to 1022	0.20 °C (0.36 °F)	±0.1	0.006 °C (0.011 °F)	±0.004
Thermocouples⁽⁸⁾						
Type B ⁽⁹⁾⁽¹⁰⁾	100 to 1820	212 to 3308	1.5 °C (2.70 °F)	±0.1	0.056 °C (0.101 °F)	±0.004
Type E ⁽⁹⁾	-50 to 1000	-58 to 1832	0.4 °C (0.72 °F)	±0.1	0.016 °C (0.029 °F)	±0.004
Type J ⁽⁹⁾	-180 to 760	-292 to 1400	0.5 °C (0.90 °F)	±0.1	0.016 °C (0.029 °F)	±0.004
Type K ⁽⁹⁾⁽¹¹⁾	-180 to 1372	-292 to 2501	0.5 °C (0.90 °F)	±0.1	0.02 °C (0.036 °F)	±0.004
Type N ⁽⁹⁾	-200 to 1300	-328 to 2372	0.8 °C (1.44 °F)	±0.1	0.02 °C (0.036 °F)	±0.004
Type R ⁽⁹⁾	0 to 1768	32 to 3214	1.2 °C (2.16 °F)	±0.1	0.06 °C (0.108 °F)	±0.004
Type S ⁽⁹⁾	0 to 1768	32 to 3214	1 °C (1.80 °F)	±0.1	0.06 °C (0.108 °F)	±0.004
Type T ⁽⁹⁾	-200 to 400	-328 to 752	0.5 °C (0.90 °F)	±0.1	0.02 °C (0.036 °F)	±0.004
DIN Type U ⁽¹²⁾	-200 to 900	-328 to 1652	0.7 °C (1.26 °F)	±0.1	0.022 °C (0.040 °F)	±0.004
DIN Type U ⁽¹²⁾	-200 to 600	-328 to 1112	0.7 °C (1.26 °F)	±0.1	0.026 °C (0.047 °F)	±0.004
Type W5Re/W26Re ⁽¹³⁾	0 to 2000	32 to 3632	1.4 °C (2.52 °F)	±0.1	0.064 °C (0.115 °F)	±0.004
GOST Type L	-200 to 800	-392 to 1472	0.50 °C (0.90 °F)	±0.1	0.003 °C (0.005 °F)	±0.004
Millivolt Input	-10 to 100 mV		0.03 mV	±0.1	0.001 mV	±0.004
2-, 3-, 4-wire Ohm Input	0 to 2000 ohms		0.7 ohm	±0.1	0.028 ohm	±0.004

(1) Input ranges are for transmitter only. Actual sensor (RTD or Thermocouple) operating ranges may be more limited.

(2) Change in ambient is with reference to the calibration temperature of the transmitter at 68 °F (20 °C) from factory.

(3) Ambient temperature effect specification valid over minimum temperature span of 28 °C (50 °F).

(4) IEC 751, 1995.

- (5) JIS 1604, 1981.
- (6) Edison Curve No. 7.
- (7) Edison Copper Winding No. 15.
- (8) Total CJC accuracy for thermocouple measurement: ± 0.5 °C.
- (9) NIST Monograph 175, IEC 584.
- (10) Fixed accuracy for NIST Type B is ± 5.4 °F (± 3.0 °C) from 212 to 572 °F (100 to 300 °C).
- (11) Fixed accuracy for NIST Type K is ± 1.3 °F (± 0.7 °C) from -292 to -130 °F (-130 to -90 °C).
- (12) DIN 43710.
- (13) ASTM E 988-96.
- (13) Accuracy and Ambient Temperature Effects are tested and verified down to -51 °C (-60 °F) for LT option.

Transmitter accuracy example

When using a Pt 100 ($a = 0.00385$) sensor input with a 0 to 100 °C span, use the greater of the two calculated values. In this case, the accuracy would be ± 0.2 °C.

Transmitter temperature effects example

Transmitters can be installed in locations where the ambient temperature is between -40 and 85 °C (-40 and 185 °F). In order to maintain excellent accuracy performance, each transmitter is individually characterized over this ambient temperature range at the factory.

When using a Pt 100 ($a = 0.00385$) sensor input with a 0–100 °C span at 30 °C ambient temperature:

- Temperature Effects: 0.006 °C \times (30 - 20) = 0.06 °C

Total transmitter error

Worst Case Transmitter Error: Accuracy + Temperature Effects = 0.2 °C + 0.06 °C = 0.26 °C

Total Probable Transmitter Error: $\sqrt{0.2^2 + 0.06^2} = 0.21$ °C

Product Certifications

Approved Manufacturing Locations

Rosemount Inc. – Chanhassen, Minnesota, USA
 Rosemount Temperature GmbH – Germany
 Emerson Process Management Asia Pacific – Singapore

European Directive Information

A copy of the EC Declaration of Conformity can be found at the end of the Quick Start Guide. The most recent revision of the EC Declaration of Conformity can be found at www.rosemount.com.

Ordinary Location Certification from FM

Approvals

As standard, the transmitter has been examined and tested to determine that the design meets the basic electrical, mechanical, and fire protection requirements by FM Approvals, a nationally recognized test laboratory (NRTL) as accredited by the Federal Occupational Safety and Health Administration (OSHA).

North America

- E5 FM Explosionproof, Dust-Ignitionproof, and Nonincendive
 Certificate: 3016555
 Standards Used: FM Class 3600:1998, FM Class 3611:2004, FM Class 3615:1989, FM Class 3810:2005, ANSI/ISA 60079-0:2009, ANSI/ISA 60079-11:2009, IEC 60529:2001, NEMA - 250: 1991
 Markings: XP CL I, DIV 1, GP B, C, D; DIP CL II/III, DIV 1, GP E, F, G when installed per Rosemount drawing 00248-1065. T5(-40 °C ≤ Ta ≤ +85 °C); NI CL1, DIV 2, GP A, B, C, D T6(-40 °C ≤ Ta ≤ +40 °C), T5(-40 °C ≤ Ta ≤ +75 °C) when installed per Rosemount drawing 00248-1055; Type 4X; IP66/68.
- I5 FM Intrinsic Safety and Nonincendive
 Certificate: 3016555
 Standards Used: FM Class 3600:1998, FM Class 3610:2010, FM Class 3611:2004, FM Class 3810:2005, ANSI/ISA 60079-0:2009, ANSI/ISA 60079-11:2009, IEC 60529:2001, NEMA - 250: 1991
 Markings: IS CL I/II/III, DIV 1, GP A, B, C, D, E, F, G; NI CL1, DIV 2, GP A, B, C, D T6(-40 °C ≤ Ta ≤ +40 °C), T5(-40 °C ≤ Ta ≤ +75 °C) when installed per Rosemount drawing 00248-1055; Type 4X; IP66/68.

Special Conditions for Safe Use (X):

- When option d=N (No Enclosure), the Model 248 Transmitter shall be installed in an enclosure meeting the requirements of ANSI/ISA S82.01 & S82.03 or other applicable ordinary location standards.
- Option d must not equal N (No enclosure) or B (Buz Head) to maintain a Type 4X rating.

- Option d must not equal N (No Enclosure) to maintain a Type 4 Rating.
- I6 CSA Intrinsic Safety and Division 2
 Certificate: 1091070
 Standards Used: CAN/CSA C22.2 No. 0-M90, CSA Std. C22.2 No. 25-1966, CAN/CSA C22.2 No. 94-M91, CAN/CSA C22.2 No. 157-92, CSA C22.2 No. 213-M1987, C22.2 No 60529-05
 Markings: IS CL I, DIV 1 GP A, B, C, D when installed per Rosemount drawing 00248-1056; Suitable for CL I DIV 2 GP A, B, C, D when installed per Rosemount drawing 00248-1055; T6(-50 °C ≤ Ta ≤ +40 °C), T5(-50 °C ≤ Ta ≤ +60 °C); Type 4X, IP66/68 for enclosure options “A”, “G”, “H”, “U”;
- K6 CSA Explosionproof, Intrinsic Safety, and Division 2
 Certificate: 1091070
 Standards Used: CAN/CSA C22.2 No. 0-M90, CSA Std. C22.2 No. 25-1966, CSA Std. C22.2 No. 30-M1986, CAN/CSA C22.2 No. 94-M91, CSA Std. C22.2 No.142-M1987, CAN/CSA C22.2 No. 157-92, CSA C22.2 No. 213-M1987, C22.2 No 60529-05
 Markings: XP CL I/II/III, DIV 1, GP B, C, D, E, F, G when installed per Rosemount drawing 00248-1066; IS CL I, DIV 1 GP A, B, C, D when installed per Rosemount drawing 00248-1056; Suitable for CL I DIV 2 GP A, B, C, D when installed per Rosemount drawing 00248-1055; T6(-50 °C ≤ Ta ≤ +40 °C), T5(-50 °C ≤ Ta ≤ +60 °C); Type 4X, IP66/68 for enclosure options “A”, “G”, “H”, “U”; Seal not required.

Europe

- E1 ATEX Flameproof
 Certificate: FM12ATEX0065X
 Standards Used: EN 60079-0: 2012, EN 60079-1: 2007, EN 60529:1991 +A1:2000
 Markings:  II 2 G Ex d IIC T6...T1 Gb, T6(-50 °C ≤ Ta ≤ +40 °C), T5...T1(-50 °C ≤ Ta ≤ +60 °C);
 See [Table 4](#) at the end of the Product Certifications section for Process Temperatures.

Special Conditions for Safe Use (X):

- See certificate for ambient temperature range.
 - The non-metallic label may store an electrostatic charge and become a source of ignition in Group III environments.
 - Guard the LCD display cover against impact energies greater than 4 joules.
 - Consult the manufacturer if dimensional information on the flameproof joints is necessary.
- I1 ATEX Intrinsic Safety
 Certificate: Baseefa03ATEX0030X
 Standards Used: EN 60079-0: 2012, EN 60079-11: 2012
 Markings:  II 1 G Ex ia IIC T5/T6 Ga, T5(-60 °C ≤ Ta ≤ +60 °C), T6(-60 °C ≤ Ta ≤ +80 °C)

See [Table 5](#) at the end of the Product Certifications section for Entity Parameters.

Special Conditions for Safe Use (X):

1. The apparatus must be installed in an enclosure which affords it a degree of protection of at least IP20. Non-metallic enclosures must have a surface resistance of less than 1GΩ; light alloy or zirconium enclosures must be protected from impact and friction when installed.

N1 ATEX Type n - Transmitter only
 Certificate: Baseefa13ATEX0045X
 Standards Used: EN 60079-0:2012, EN 60079-15:2010
 Markings:  II 3 G Ex nA IIC T5/T6 Gc, T5(-60 °C ≤ Ta ≤ +80 °C), T6(-60 °C ≤ Ta ≤ +60 °C);

Special Condition for Safe Use (X):

1. The Model 248 Temperature Transmitter must be installed in a suitably certified enclosure such that it is afforded a degree of protection of at least IP54 in accordance with IEC 60529 and EN 60079-15.

NC ATEX Type n - Temperature Assembly
 Certificate: BAS00ATEX3145
 Standards Used: EN 60079-0:2012, EN 60079-15:2010
 Markings:  II 3 G Ex nA IIC T5 Gc (-40 °C ≤ Ta ≤ +70 °C);

ND ATEX Dust
 Certificate: FM12ATEX0065X
 Standards Used: EN 60079-0: 2012, EN 60079-31: 2009, EN 60529:1991 +A1:2000
 Markings:  II 2 D Ex tb IIIC T130 °C Db, (-40 °C ≤ Ta ≤ +70 °C); IP66

Special Conditions for Safe Use (X):

1. See certificate for ambient temperature range.
2. The non-metallic label may store an electrostatic charge and become a source of ignition in Group III environments.
3. Guard the LCD display cover against impact energies greater than 4 joules.
4. Consult the manufacturer if dimensional information on the flameproof joints is necessary.

Technical Regulations Customs Union (EAC)

KM, IM, EM Contact an Emerson Process Management representative for additional information

International

E7 IECEx Flameproof
 Certificate: IECEx FMG 12.0022X
 Standards Used: IEC 60079-0:2011, IEC 60079-1:2007-04, IEC 60079-31:2008

Markings: Ex d IIC T6...T1 Gb, T6(-50 °C ≤ Ta ≤ +40 °C), T5...T1(-50 °C ≤ Ta ≤ +60 °C); Ex tb IIIC T130 °C Db, (-40 °C ≤ Ta ≤ +70 °C); IP66;

See [Table 4](#) at the end of the Product Certifications section for Process Temperatures

Special Conditions for Safe Use (X):

1. See certificate for ambient temperature range.
2. Guard the LCD display cover against impact energies greater than 4 joules.
3. Consult the manufacturer if dimensional information on the flameproof joints is necessary.

I7 IECEx Intrinsic Safety
 Certificate: IECEx BAS 07.0086X
 Standards Used: IEC 60079-0:2011, IEC 60079-11:2011
 Markings: Ex ia IIC T5/T6 Ga, T5(-60 °C ≤ Ta ≤ +80 °C) T6(-60 °C ≤ Ta ≤ +60 °C)
 See [Table 5](#) at the end of the Product Certifications section for Entity Parameters

Special Condition for Safe Use (X):

1. The apparatus must be installed in an enclosure which affords it a degree of protection of at least IP20. Non-metallic enclosures must have a surface resistance of less than 1GΩ; light alloy or zirconium enclosures must be protected from impact and friction when installed.

N7 IECEx Type n - Transmitter only
 Certificate: IECEx BAS 13.0029X
 Standards Used: IEC 60079-0:2011, IEC 60079-15:2010
 Markings: Ex nA IIC T5 Gc; T5(-40 °C ≤ Ta ≤ +70 °C)

Special Conditions for Safe Use (X):

1. The Model 248 Temperature Transmitter must be installed in a suitably certified enclosure such that it is afforded a degree of protection of at least IP54 in accordance with IEC 60529 and IEC 60079-15.
- NG IECEx Type n - Temperature Assembly
 Certificate: IECEx BAS 07.0055
 Standards Used: IEC 60079-0:2011, IEC 60079-15:2010
 Markings: Ex nA IIC T5/T6 Gc; T5(-60 °C ≤ Ta ≤ +80 °C), T6(-60 °C ≤ Ta ≤ +60 °C)

China

E3 China Flameproof
 Certificate: GYJ11.1534;
 Standards Used: GB3836.1-2010, GB3836.2-2010
 Markings: Ex d IIC T6 Gb (-40 °C ≤ Ta ≤ +65 °C)

Special Conditions of Use (X):

1. Ambient temperature range is: $-40\text{ }^{\circ}\text{C} \leq T_a \leq +65\text{ }^{\circ}\text{C}$.
2. The earth connection facility in the enclosure should be connected reliably.
3. During installation, there should be no mixture harmful to flameproof housing.
4. During installation in hazardous location, cable glands, conduits and blanking plugs, certified by state-appointed inspection bodies with Ex d IIC Gb degree, should be used.
5. During installation, use and maintenance in explosive gas atmospheres, observe the warning “Do not open when energized”.
6. End user is not permitted to change any components inside, but to settle the problem in conjunction with manufacturer to avoid damage to the product.
7. When installation, use and maintenance of this product, observe the following standards:

GB3836.13-1997 “Electrical apparatus for explosive gas atmospheres Part 13: Repair and overhaul for apparatus used in explosive gas atmospheres”.

GB3836.15-2000 “Electrical apparatus for explosive gas atmospheres Part 15: Electrical installations in hazardous area (other than mines)”.

GB3836.16-2006 “Electrical apparatus for explosive gas atmospheres Part 16: Inspection and maintenance of electrical installation (other than mines)”.

GB50257-1996 “Code for construction and acceptance of electric device for explosion atmospheres and fire hazard electrical equipment installation engineering”.

- 13 China Intrinsic Safety
 Certificate: GYJ11.1535X
 Standards Used: GB3836.1-2010, GB3836.4-2010
 Markings: Ex ia IIC T5/T6; T5($-60\text{ }^{\circ}\text{C} \leq T_a \leq +80\text{ }^{\circ}\text{C}$), T6($-60\text{ }^{\circ}\text{C} \leq T_a \leq +60\text{ }^{\circ}\text{C}$)
 See [Table 5](#) at the end of the Product Certifications section for Entity Parameters.

Special Conditions for Safe Use (X):

1. Symbol “X” is used to denote specific conditions of use:
 - a. The enclosure may contain light metal, attention should be taken to avoid ignition hazard due to impact or friction.
 - b. The apparatus must be installed in an enclosure which affords it a degree of protection of at least IP20. Non-metallic enclosures must have a surface resistance of less than $1\text{G}\Omega$.
2. The relation between T code and ambient temperature range is:

T code	Temperature range
T6	$-60\text{ }^{\circ}\text{C} \leq T_a \leq +60\text{ }^{\circ}\text{C}$
T5	$-60\text{ }^{\circ}\text{C} \leq T_a \leq +80\text{ }^{\circ}\text{C}$

3. Intrinsically Safe parameters:
 HART loop terminals (+ and -)

Maximum input voltage U_i (V)	Maximum input current I_i (mA)	Maximum input power: P_i (W)	Maximum internal parameters	
			C_i (nF)	L_i (mH)
30	130	1.0	3.6	0

The above supply must be derived from a linear supply.

Sensor terminals (1 to 4)

Maximum output voltage U_o (V)	Maximum output current I_o (mA)	Maximum output power: P_o (W)	Maximum internal parameters	
			C_i (nF)	L_i (mH)
45	26	290	2.1	0

Sensor terminals (3 to 6)

Group	Maximum external parameters	
	C_o (nF)	L_o (mH)
IIC	23.8	23.8
IIB	237.9	87.4
IIA	727.9	184.5

4. The product should be used with Ex-certified associated apparatus to establish explosion protection system that can be used in explosive gas atmospheres. Wiring and terminals should comply with the instruction manual of the product and associated apparatus.
5. The cables between this product and associated apparatus should be shielded cables (the cables must have insulated shield). The shielded has to be grounded reliably in non-hazardous area.
6. End user is not permitted to change any components inside, but to settle the problem in conjunction with manufacturer to avoid damage to the product.
7. When installation, use and maintenance of this product, observe the following standards:

GB3836.13-1997 “Electrical apparatus for explosive gas atmospheres Part 13: Repair and overhaul for apparatus used in explosive gas atmospheres”.

GB3836.15-2000 “Electrical apparatus for explosive gas atmospheres Part 15: Electrical installations in hazardous area (other than mines)”.

GB3836.16-2006 “Electrical apparatus for explosive gas atmospheres Part 16: Inspection and maintenance of electrical installation (other than mines)”.

GB50257-1996 “Code for construction and acceptance of electrical device for explosion atmospheres and fire hazard electrical equipment installation engineering”.

- N3 China Type n
 Certificate: GYJ101095
 Standards Used: GB3836.1-2000, GB3836.8-2003
 Markings: Ex nA nL IIC T5 ($-40\text{ }^{\circ}\text{C} \leq T_a \leq +70\text{ }^{\circ}\text{C}$)

Special Conditions for Safe Use (X):

1. 248 type Temperature Assembly using temperature sensor type 65, 68, 183, 185 are certified.
2. The ambient temperature range is: (-40 °C ≤ Ta ≤ +70 °C).
3. Maximum input voltage: 42.4V.
4. Cable glands, conduit or blanking plugs, certified by NEPSI with Exe or Ex n protection type and ½-14NPT or M20x1.5 thread type, should be used on external connections and redundant cable entries.
5. Maintenance should be done in non-hazardous location.
6. End user is not permitted to change any components inside, but to settle the problem in conjunction with manufacturer to avoid damage to the product.
7. When installation, use and maintenance of this product, observe the following standards:

GB3836.13-1997 “Electrical apparatus for explosive gas atmospheres Part 13: Repair and overhaul for apparatus used in explosive gas atmospheres”.

GB3836.15-2000 “Electrical apparatus for explosive gas atmospheres Part 15: Electrical installations in hazardous area (other than mines)”.

GB3836.16-2006 “Electrical apparatus for explosive gas atmospheres Part 16: Inspection and maintenance of electrical installation (other than mines)”.

GB50257-1996 “Code for construction and acceptance of electrical device for explosion atmospheres and fire hazard electrical equipment installation engineering”.

Combinations

- K5 Combination of E5 and I5

Tables

Table 4. Process Temperatures

Temperature class	Ambient temperature	Process temperature w/o LCD display cover (°C)			
		No ext.	3”	6”	9”
T6	-50 °C to +40 °C	55	55	60	65
T5	-50 °C to +60 °C	70	70	70	75
T4	-50 °C to +60 °C	100	110	120	130
T3	-50 °C to +60 °C	170	190	200	200
T2	-50 °C to +60 °C	280	300	300	300
T1	-50 °C to +60 °C	440	450	450	450

Table 5. Entity Parameters

	HART loop terminals + and -	Sensor terminals 1 to 4
Voltage U _i	30 V	45 V
Current I _i	130 mA	26 mA
Power P _i	1 W	290 mW
Capacitance C _i	3.6 nF	2.1 nF
Inductance L _i	0 mH	0 μH

Table 6. Intrinsic Safety Parameters

Terminals	Input parameters					Output parameters				
	U_i , *V	I_i , *mA	P_i , *W	L_i , μ H	C_i , nF	U_o , V	I_o , mA	P_o , mW	L_o , μ H	C_o , μ F
+and-	30	130	1	0	3.6	N/A	N/A	N/A	N/A	N/A
1-4	N/A	N/A	N/A	0	2.1	45	26	290	N/A	N/A

Special Conditions for Safe Use (X):

1. Transmitter installation and operation must follow requirements and special conditions for safe use given in operation manuals.
2. Transmitters must be powered by intrinsic safety barriers having certificate of compliance.
3. Electrical parameters shown on the intrinsic safety barrier, together with connecting cable parameters, should correspond to input intrinsic safety parameters of sensors and transmitters.
4. Transmitter housing is made of aluminum alloy, thus to prevent ignition from sparks caused by friction or collision of parts it is required to protect sensor and transmitter housing against mechanical shocks when installing them in Zone 0.
5. Transmitters to be mounted with no connection head should be installed within an enclosure rated at IP 20 per GOST 14254-96 at least.

Dimensional Drawings

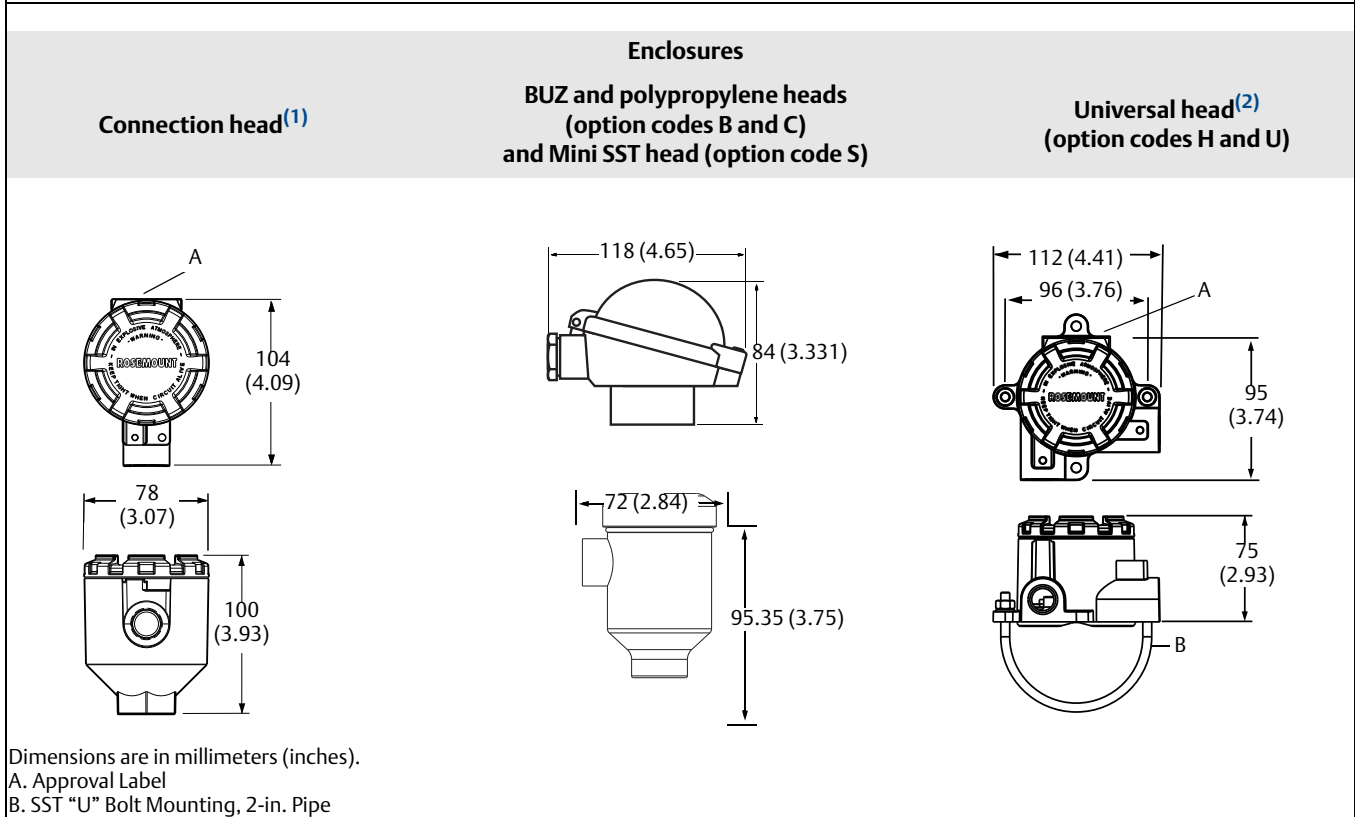
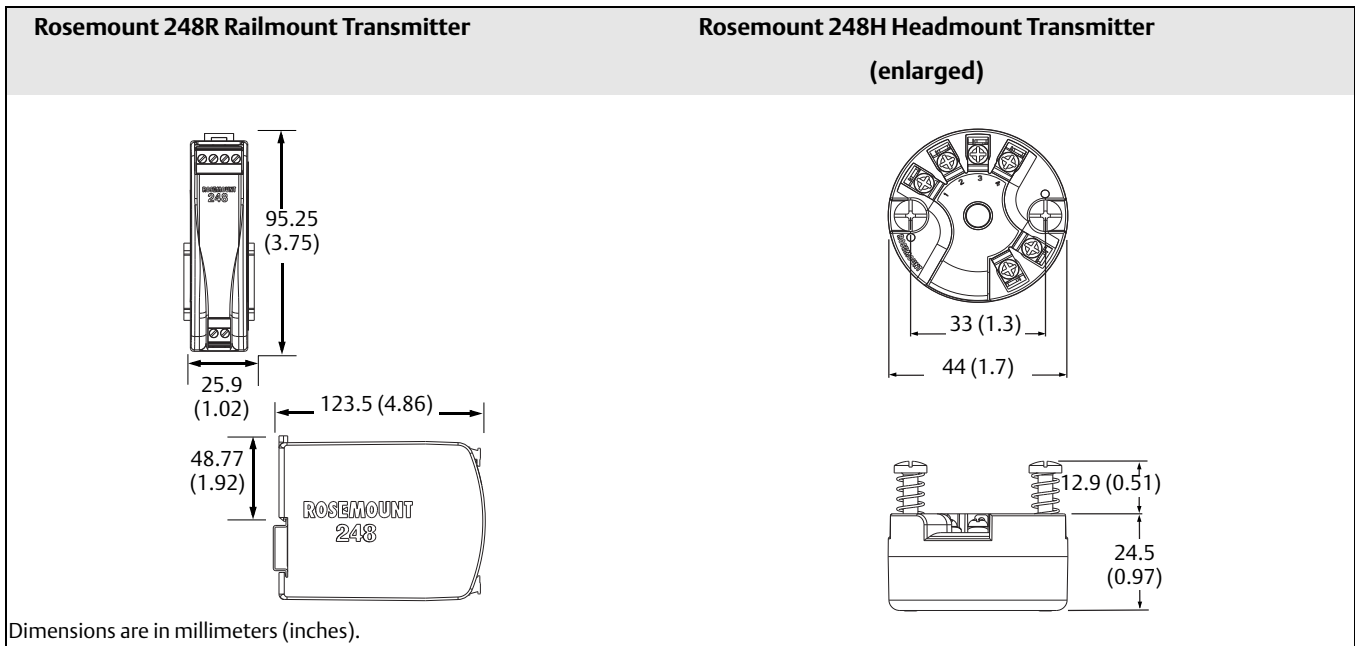

(1) If ordering the transmitter with a DIN style sensor, it is recommended that the enclosure be ordered within the sensor model (Product Data Sheet 00813-0200-2654) rather than within the transmitter model, in order to drive necessary parts.

(2) A "U" Bolt is shipped with each universal head unless a sensor is ordered assembled to the enclosure. However, since the head can be integrally mounted to the sensor, it may not need to be used.

Rosemount 248 Configuration Interface Specifications

Configuration software⁽¹⁾

The Rosemount 248 PC-based configuration software for the Rosemount 248 allows comprehensive configuration of the transmitters. Used in conjunction with various Rosemount or user-supplied hardware modems, the software provides the tools necessary to configure the 248 Transmitters including the following parameters:

- Process Variable
- Sensor Type
- Number of Wires
- Engineering Units
- Transmitter Tag Information
- Damping
- Alarming Parameters

Configuration hardware

The 248 Configuration Interface has 3 hardware options as follows:

Software only

(Part #: 00248-1603-0002)

Customer must provide appropriate communications hardware (modem, power supply, etc.).

Serial HART modem and software

■ (Part #: 00248-1603-0004)

- Serial HART modem
- Customer must provide separate loop power supply and resistor.
- Requires PC serial port.
- *Suitable for use with powered loops.*

USB HART modem and software

■ (Part #: 00248-1603-0003)

- USB (Universal Serial Bus) HART modem
- Customer must provide separate loop power supply and resistor.
- Requires PC with USB port.
- *Suitable for use with powered loops.*

(1) The Rosemount configuration software is compatible with Windows™ XP, Windows 7 32-bit and Windows 7 64-bit. It is not compatible with Windows NT and Windows 2000.

Table 7. Rosemount 248 Transmitter Accessories

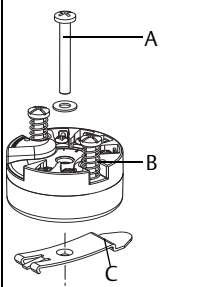
	Part description	Part number
 <p>A. Mounting Hardware B. Transmitter C. Rail Clip</p>	Aluminum Alloy Universal Head – M20 Entries	00644-4420-0002
	Aluminum Alloy Universal Head – 1/2 NPT Entries	00644-4420-0001
	Aluminum Alloy Rosemount Connection Head – M20 Conduit Entry, M24 Instrument Entry	00644-4410-0023
	Aluminum Alloy Rosemount Connection Head – 1/2 NPT Conduit Entry and M24 Instrument Entry	00644-4410-0013
	Aluminum Alloy BUZ Head – M20 Conduit Entry, M24 Instrument Entry	00644-4196-0023
	Aluminum Alloy BUZ Head – M20 Conduit Entry and 1/2 NPT Instrument Entry	00644-4196-0021
	Aluminum Alloy BUZ Head – 1/2 NPT Conduit Entry	00644-4196-0011
	External Ground Screw Assembly Kit	00644-4431-0001
	Kit, Hardware for Mounting a 248 to a DIN Rail (see left picture-top hat rail, symmetric)	00248-1601-0001
	Standard Cover for Universal or Rosemount Connection Heads	03031-0292-0001
	Snap Rings Kit (used for assembly to DIN Plate Style sensor)	00644-4432-0001
	Rosemount 248 Programming Software (CD)	00248-1603-0002
	Rosemount 248 Programming Kit - Serial connection	00248-1603-0004
	Rosemount 248 Programming Kit - USB connection	00248-1603-0003

Hardware tag

- 20 characters maximum
- Transmitter enclosure, sensor, and thermowell if applicable will be tagged in accordance with customer requirements

Software tag

- The transmitter can store up to 8 characters. If no characters are specified, the first 8 characters of the hardware tag are the default.

Configuration

When ordering a transmitter and sensor assembly in one model number, the transmitter will be configured for the sensor that is ordered.

When a transmitter is ordered alone, the transmitter will be shipped as follows (unless specified):

Sensor type	RTD, Pt 100 ($\alpha=0.00385$, 4-wire)
4 mA value	0 °C
20 mA value	100 °C
Damping	5 seconds
Output	Linear with temperature
Failure mode	High/Upscale
Line voltage filter	50 Hz
Tag	See Hardware tag

Options

The following table lists the requirements necessary to specify a custom configuration.

Option code	Requirements/specification
C1: Factory Configuration Data (CDS required)	Date: day/month/year Descriptor: 16 alphanumeric characters Message: 32 alphanumeric character Analog Output: Alarm and saturation levels
A1: NAMUR-Compliant, High Alarm	See Figure 1 on page 9 .
CN: NAMUR-Compliant, Low Alarm	See Figure 1 on page 9 .
Q4: Calibration Certificate	Will include 3-Point calibration at 0, 50, and 100% analog and digital output points
C4: Five Point Calibration	Will include 5-point calibration at 0, 25, 50, 75, and 100% analog and digital output points. Use with Calibration Certificate Q4.
F6: 60 Hz Line Filter	Calibrated to a 60 Hz line voltage filter instead of 50 Hz filter



ZPA Nová Paka, a.s.

Pražská 470
509 39 Nová Paka
Czech republic

tel.: + 420 493 761 234

fax: + 420 493 721 194

e-mail: obchod@zpanp.cz

www.zpanp.cz